



FOR AGES  
**14+**

# **PRO 15**

## **FPV CAMERA FOLDING DRONE**

### **ALTITUDE HOLD VERSION**

## **USER'S MANUAL**

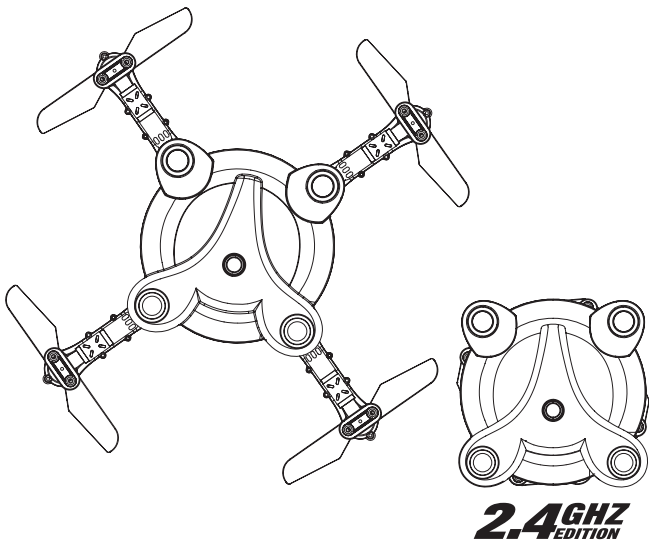

**PLEASE CAREFULLY READ THE  
INSTRUCTION MANUAL BEFORE FLYING.**

[WWW.RCPRO.CA](http://WWW.RCPRO.CA)

## IMPORTANT SAFETY INFORMATION

- (1) THIS PRODUCT IS NOT A TOY. Proper assembly of unit is important to ensure correct operation. Improper use or assembly may result in SERIOUS personal or property damage. Our company accepts no responsibility for any damages incurred by the owner/operator's misuse. Please use special care assembling and operating this product for optimum enjoyment and safety.
- (2) This product is for users over 14 years or age.
- (3) Please refer to local bylaws as to where you can legally fly.
- (4) The manufacturer is not responsible for any damage/security issues after unit is sold.
- (5) Please contact us at [www.rcpro.ca](http://www.rcpro.ca) or alternatively, visit your local vendor for information regarding after sales maintenance and repair.

## SAFETY PRECAUTIONS

DO NOT operate drone in a crowded area. Unexpected conditions, technical issues or improper assembly may cause unplanned manoeuvring, which can cause serious injury and/or property damage. The operator of this product accepts all responsibility for any damages caused by its misuse.

1. KEEP AWAY from people and obstacles including high-rise buildings, high voltage wires, etc.
2. DO NOT store the drone in a damp environment. The drone's interior is composed of delicate electronic components and mechanical parts, which can be seriously damaged by moisture. Please take serious care, as this type of damage may not be visible on the outside, but can cause the product damage or act unpredictably once in use.
3. Always operate with safety in mind. DO NOT use this drone under the influence of drugs or alcohol, or in the case of fatigue, as improper operation can cause serious injury and/or property damage.
4. KEEP AWAY from rotating parts once the drone is in motion. Propeller blades can cause serious harm to people and property.
5. DO NOT store or operate in high heat, as electrical components can be damaged.

Remote control drone by the metal, fiber, plastic, electronic components and other materials, so as far as possible away from heat, to prevent the sun, to avoid deformation or even damage caused by high temperature.

---

**WARNING:** Lithium batteries are vulnerable to moisture, high heat, pressure, puncture, etc. Lithium Ion batteries are both lighter in weight and more powerful. This makes them less durable than a traditional alkaline battery, and so extra care must be used when handling. Improper handling may lead to fire and/or explosion. RC-PRO is not responsible for any damage or injury occurring from proper or improper use of this drone, batteries and the rest of the provided parts.

- ⚠ ● REMOVE BATTERY from the drone while charging.
- If you are planning to store your drone for extended periods, keep battery charged 50% to increase the life of your battery.
- Charge your battery at least once every 4 months or the battery may damage.
- Do not leave a battery charging without supervision.
- Use ONLY the provided charger to charge your lithium ion batteries.
- Do not leave battery charger in a carpeted area in case of fire.
- Make sure batteries stored for extended periods are properly charged before use.

## PARTS LIST



Drone X1



Transmitter X1



A/B Blade X2



Li-po Battery  
3.7V 300MAh X1



USB Charging  
Cable X1



Phone Holder X1



Screwdriver X1



Carry Bag X1



Instruction Manual X1

## DRONE INSTRUCTION

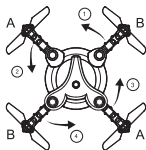
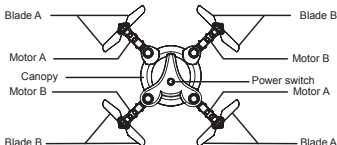

Arms folding order-fold the front arms near the camera first, then the back arms (opposite when unfold them).

## REMOTE CONTROLLER FUNCTIONS

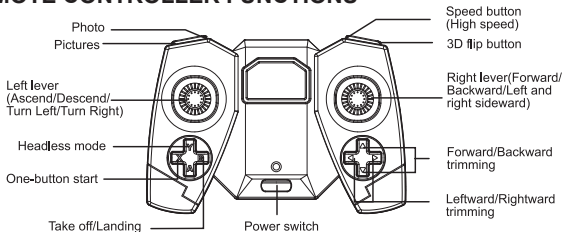

## REMOTE CONTROL AND DRONE BATTERY INSTALLATION AND CHARGING INSTRUCTIONS



Insert the battery correctly as shown in the illustration (+ / -) of the battery compartment as shown.

## CHARGING BATTERY

1. Connect the USB charging cable to a power source, then the battery to the charger. When battery is charged the red indicator light will turn on
2. Insert the charged battery into the drone and align the battery plug with the input socket on the drone



The battery is charging



## PREPARING TO FLY

1. Connect the power plug of the drone to the lithium battery socket. Press the power button for 2 seconds and place the drone on a flat surface.
2. Please put the drone in an open space. Before flight, please make sure that the rear part of drone is pointing to you directly.
3. The camera of drone indicates the forward direction, conversely, the backward direction.
4. Turn the remote control on and push the left lever up and down, you will hear a "beep" sound and the light will stop flashing. At this point your drone is paired with the remote control and ready to fly.

## CONTROL INSTRUCTIONS

One key take-off and landing

Press (1) push the left stick up to takeoff.

Left and right hand throttle switch.

To switch throttle from left to right hand, press (1) and (2) together, raise the left stick. This will move the throttle from the left joystick to the right stick, for left handed flyers.

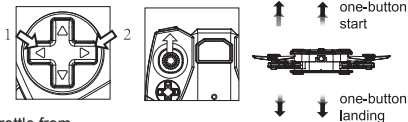

### Flight control

#### A. Throttle (Left lever)

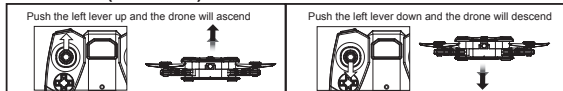

#### B. Forward and backward (Right lever)

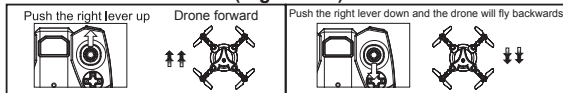

#### C. Left and right side of the fly

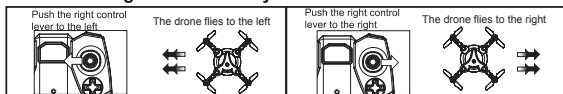

#### D. Turn left and right

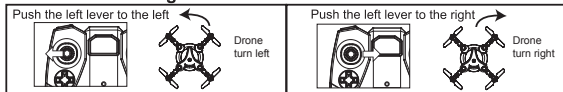

# TRIMMING INSTRUCTIONS

## Forward and backward trimming

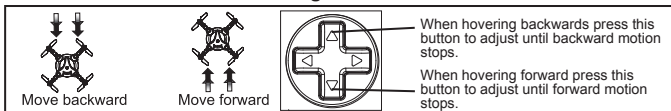

## Left and right trimming

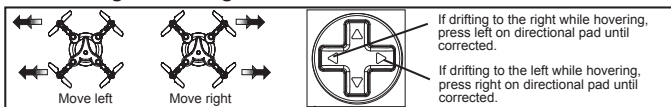

## What is Headless Mode and How to Use it

When switching to headless mode, the aircraft will abandon its front, rear, left and right orientations, and reposition the front and back with the remote control as the reference point. For example, when the right control lever is pushed forward, the aircraft will fly away from the remote control.

1. Place the drone exactly in front of you with its nose pointing forward and press the "headless mode" button on the remote control. You are now flying headless.
2. As long as the drone is in headless mode the remote control will sound a "beep" sound every few seconds. This sound will stop as soon as the user will return to normal flight mode.

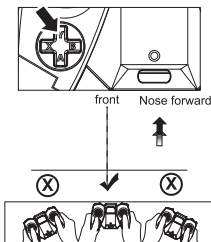

## Speed Control



Speed settings apply to all four directions. There are two speeds. To switch to Fast Mode while in flight, press the accelerator button on the controller. A double beep will sound. To return to Regular Mode (recommended for beginners), press the accelerator button again. A single beep will sound to signal the switch.

## Calibrating the Gyroscope

1. If the gyroscope is not calibrated, the drone will wobble while hovering. This can be adjusted.
2. Before operation, place the aircraft on a level horizontal surface. Hold both joysticks of the controller down and outward (as shown) until the remote issues a double beep. A light will flash on the drone to signal the reset/calibration.



## Emergency Shutdown

If a danger is encountered while flying, Emergency Shutdown can be issued to immediately stop the drone. With long press the One-button start button for 2 seconds. This function should not be performed at high altitudes, as the drone WILL immediately fall from its position and hit the surface.



## 3D Flips

Once you have mastered basic functions, try out the 3D flip function! Make sure the drone is at least 3m above the ground and press the Roll button (as shown), then move the right lever in the direction of your intended flip (Pressing upward will flip the drone over forward, etc)



## TROUBLESHOOTING

Problem	Reason	Approach
The drone is instable while flying	1. The drone is not trimmed	1. Perform trimming close to the ground (Page 4)
	2. The drone is not calibrated	2. Perform gyroscope calibration (Page 5)
	3. The drone's blades are damaged	3. Replace the blades according to page 3 diagram
	4. Wind is too strong	4. Do not fly in windy conditions
Remote control status light does not light	1. Controller is turned off	1. Turn switch to ON position
	2. Battery is incorrectly inserted	2. Check that batteries are inserted correctly
	3. Battery has no charge	3. Replace the batteries with new ones
Can not Control	1. The remote control is not turned on	1. Turn switch to ON position
	2. The drone battery is not connected	2. Check battery connection of the drone
	3. The remote control frequency has not paired with the drone	3. Turn the remote control off and on again to reset the connection
	4. Wind is too strong	4. Do not fly in windy conditions
The drone will not ascend	1. Rotor speed is too slow	1. Push up on the left lever
	2. Drone battery is too low	2. Charge the aircraft battery
	3. The blades are not positioned properly	3. Refer to the page 3 for proper blades positioning
The drone crashed instead of land	Improper use of the emergency shutdown feature.	Make sure you use the auto landing button for easy landing

## Product main accessories name



Fuselage  
01



Bottom cover  
02



Blade A  
03



Blade B  
04



Motor A  
05



Motor B  
06



Lithium battery  
07



WiFi / camcorder  
08



Flight control board  
09



Transmission gear set  
10



Screw package  
11



Rotor head  
12

# APP INSTRUCTION MANUAL

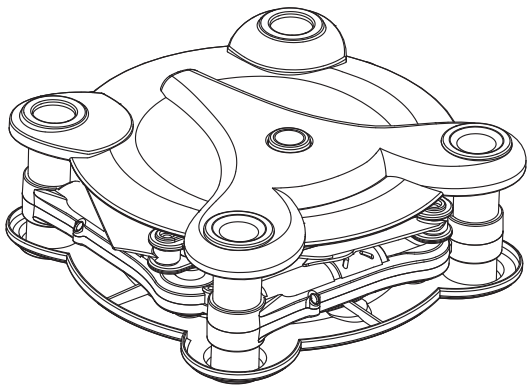

## WiFi FPV



Android



ios



Available on the  
**App Store**

# 1. Wifi Conneciton

1).Use your phone to scan the QR code, download and install the control software.



IOS



GOOGLE

2).Turn on the drone and the lights will flash; turn on your mobile phone to connect WIFI " RC-PRO \*\*\*\*\*" ,as shown in figure 2.



Figure1

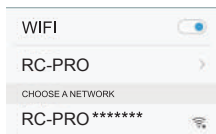

Figure2



Figure3

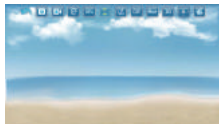

Figure4



Figure5



Figure6

3).Open the APP, enter the main interface, as shown in figure 3. Click "▶" into the main screen , as shown in figure 4. Click  Off to enter ordinary control interface, as shown in figure 5.Click  Altitude Hold key becomes yellow, and enter the Altitude Hold interface, as shown in figure 6.

4).Once to connected to your drone by Wifi, you will be able to view the camera transmit through your APP.

## 2.APP Interface Description





- 1.Return
- 2.Photo
- 3.Video
- 4.Photo book
- 5.Speed
- 6.Altitude hold mode
- 7.Gravity
- 8.ON/OFF
- 9.Camera reverse
10. 3D display
- 11.Headless mode
- 12.Gyro calibration
- 13.Ascend
- 14.Turn Left
- 15.Turn right
- 16.Descend
- 17.3D Filp
- 18.Track-controlled mode
- 19.Fly to the left
- 20.Fly Forward
- 21.Fly to the right
- 22.Forward/Backward fly fine-tuning
- 23.Fly backwad
- 24.One key take off
- 25.Left/Right rotation fine-tuning
- 26.STOP
- 27.Left/Right side fly fine-tuning
- 28.One key landing

### 3.APP Functions

#### 1). Auto-Takeoff

1. Place the drone on a flat surface.
2. Press the "Altitude hold" button" (Figure1).
3. Press the "Auto-Takeoff" button" (Figure2).



Figure1



Figure2

Attention: Please make sure you disconnect the battery from the drone after every flight in order to prevent damage to the battery.

- 2). Speed control: Click into speed control, put your right hand thumb on the right lever, will be mobile phone swing to completed (Figure3).
- 3). Selfie feature: Guide the drone to point right at you and press the camera button to take selfies(Figure 4)



Figure3



Figure4

Attention: Selfie-taking must be practiced when you are skillful enough to control the drone.

One-key calibration: This function is only allowed on the ground.

## 4).Flight operation



Push up the left lever, the rotating speed of main blades increase, the drone will ascend.

Push down the left lever, the rotating speed of main blades decrease, the drone will descend.

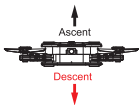

Push the left lever to the left, the drone will turn left.  
Push the left lever to the right, the drone will turn right.



Push up the right lever, the drone will fly forward.  
Push down the right lever, the drone will fly backward.

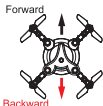

Push the right lever to the right, the drone will fly sideways to the right.  
Push the right lever to the left, the drone will fly sideways to the left.

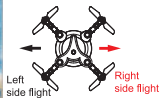

Attention: Push the left lever (slowly) to take off. If the drone is not stable refer to the trimming instructions or perform calibration.



If the drone keeps turning left/right while hovering, press the right/left trimming on the bottom left of the screen to adjust.

If the drone keeps flying left/right sideways while hovering, press the right/left sideways trimming on the bottom right of the screen to adjust.

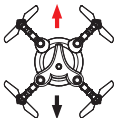
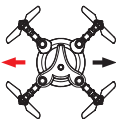

If the drone keeps flying forward/backward while hovering, press the forward/backward trimming on the far right of the screen to adjust.

Attention: When the drone is within 30cm from the ground, it will be affected by the blade vortex made by itself and become unstable. This is "ground effect". The lighter the drone is, the greater the effect will be.

## 5).Altitude Hold

When you release the left lever after the up/down operation, the drone will still hover over the height when the lever is released.

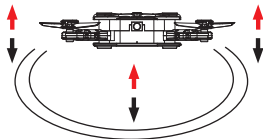

## 6).3D Flips

Once you have mastered basic functions, try out the 3D flip function! Make sure the drone is at least 3m above the ground and press the 360° Roll key , then move the right lever in the direction of your intended flip (Pressing upward will flip the drone over forward, etc)

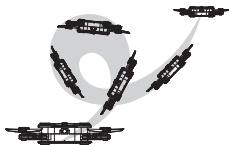

## 7).Track Control Mode

Once pressing the "Track control" key the right lever will disappear from the right side of the APP screen. Use your finger tip to draw a "flight-plan" for your drone and the drone will fly accordingly.

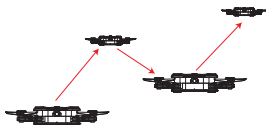

## 8).Gravity Function

Switch this feature key on and use your phone as a motion controller. Move your phone forward and the drone will fly forward etc.



- 1.Right and left control:when the phone is flat, the left inclining drives the drone to the left side; the right inclining drives the drone to the right side
- 2.Forward and backward control: when the phone is flat,the forward inclining drives the drone to the front; the backward inclining drives the drone to the backward.

## 9).Headless Mode

This function means that the drone's direction of flight seen from your viewpoint follows the phone directly, no matter in which direction the drone's is pointing. Follow these steps to use this function:

(1) Place the drone exactly in front of you with its nose pointing to your forward.

(2) Press the "Headless mode" key .

You are now able to fly your drone without considering to which direction the nose is pointing. To disable the "Headless mode" press on the same button again.

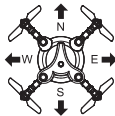

## 10).Gyro Calibration

1. If the drone does not hover properly and does not fly accurately then gyro calibration might be needed in order to reset the gyroscope.
2. Place the drone on a flat surface, press  and the drone's light will flash several time quickly and then return to normal operation. Calibration complete.

## 11).3D Goggles

Press the 3D button , and you can see separate screen on your phone, then you can put your phone into a VR goggles for a 3D real-time viewing.



## 4.Choosing When to Fly

- 1).Indoor flying choose a wide place without barriers, pets and people.
- 2).Outdoor flying: Choose a warm, sunny and windless day.
  - ① Do not fly in extreme temperatures. Flying in extreme temperatures may affect the performance and damage the product.
  - ② Do not fly in windy days. The performance and the control of the drone will be affected by the strong winds. Flying in winds condition may cause disappearance or damages to the drone.

### 3).Flight training

You can try to fly a square, cross-shaped pattern after the fundamental flight training of fixed-point take-off, landing, rotation and other basic exercises.

We believe that you should make the most out of your drone. If you are ever in need of advice, service or parts please visit our website for a list of our retailers.

WWW.RCPRO.CA